

Skyvision SV C250	
Poids * (hors PO)	15.5kg
Encombrement	422 x 442 x 918mm
Type de Barillet	3x3 points
Miroir Primaire	Suprax Ø250-45 x 30mm - réflexion >96%
Ø Utile Primaire	247mm
Fixation	Queue d'aronde type Losmandy

Caracteristiques	CASSEGRAIN f/D:16
Porte Oculaire	Non fourni - Option recommandée : Primalucelab Esatto 2"
Correcteur de Coma	/
Tirage	212mm (à partir de la face arrière)
Champ de Pleine Lumière	Ø30mm
Longueur Focale	4000
Ouverture f/D	30
Diamètre Miroir Secondaire	70mm
Obstruction	9% de la surface - 30% du diamètre

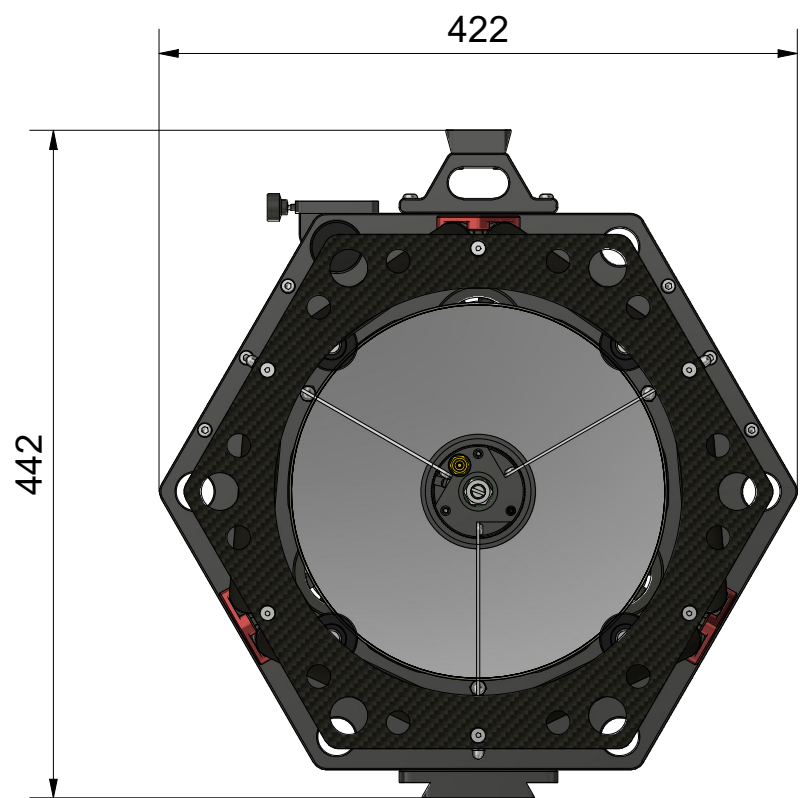

Cassegrain : Ø250 - f: 4000 - f/D: 16

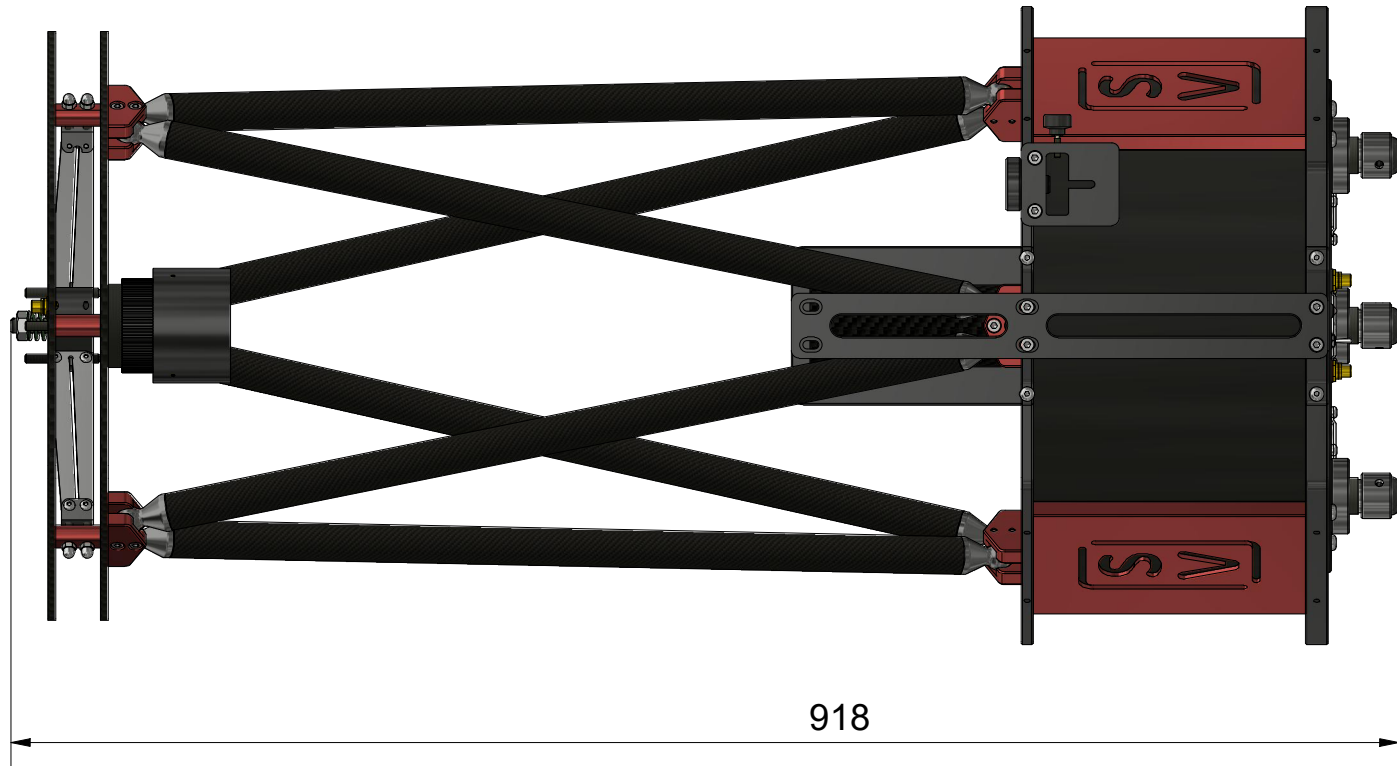